

SMW

basic @ level

▶ 7
 ▶ 1
 + ()
 ,
 - Peek
 FDA, EHEDG

▶ . Nr. 1.4305
 :
 - M12
 - G1/2"
 - Peek
 CIP 0..+ 150°C (30)
 18...32 VDC
 ()
 50 mA max
 < 0,2s
 10..+70°C
 0..+100°C
 -20...+70°C
 10 bar max
 ()
 ▶ Ma IP69K 5...10 Nm



6	5	4	/ %	
0	0	0	86	84
0	0	1	97	96
0	1	0	72	70
0	1	1	60	58
1	0	0	50	48
1	0	1	11	9
1	1	0	5	4
1	1	1		()

Schalter		Verzögerung in sec
3	2	
0	0	0
0	1	2
1	0	4
1	1	8

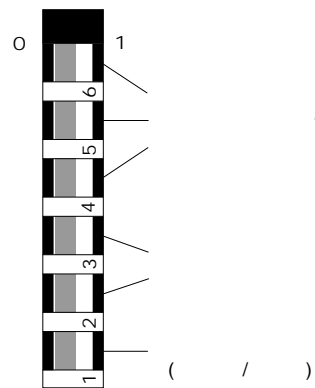

:
 SMW -
 ▶ /
 ▶ "
 ▶ "

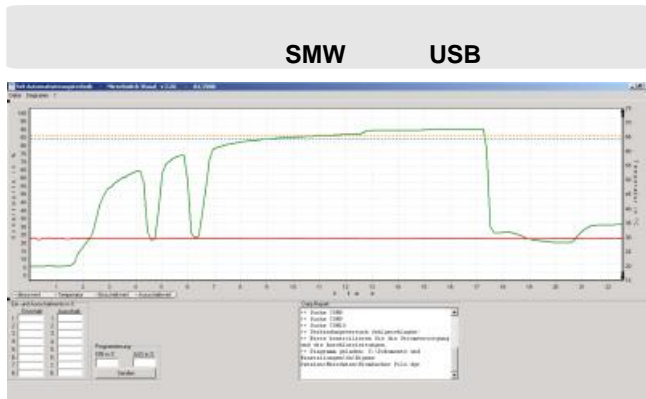

SMW

basic @ level

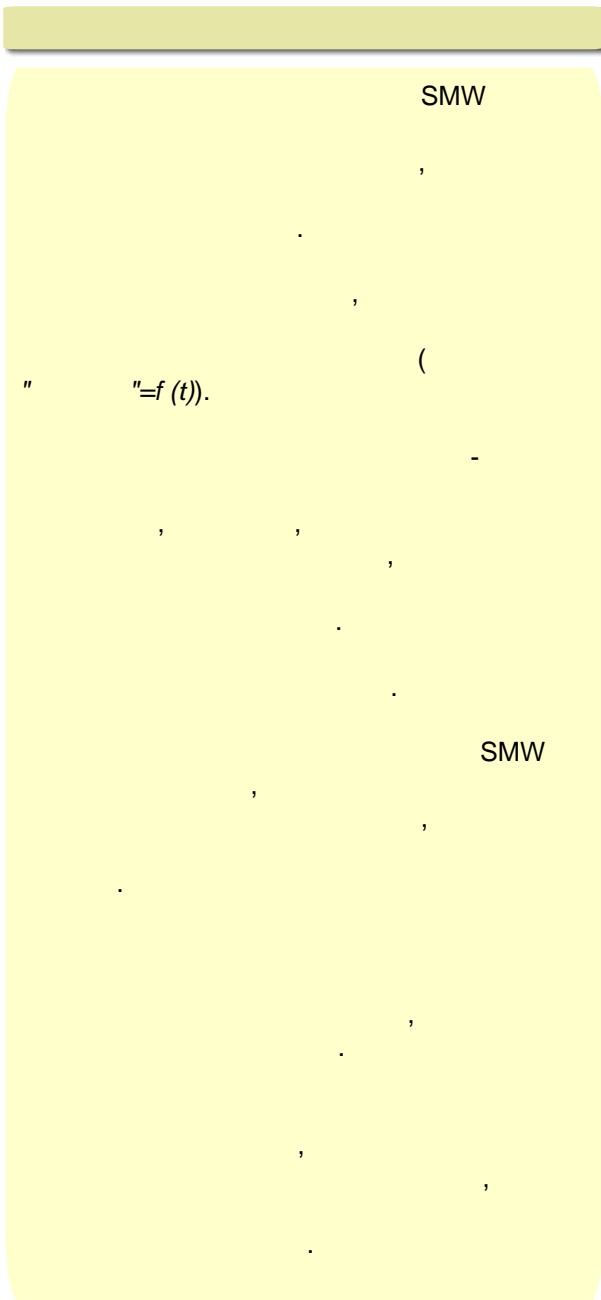

SMW

" =f (t).

SMW

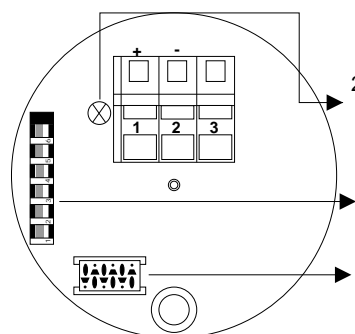
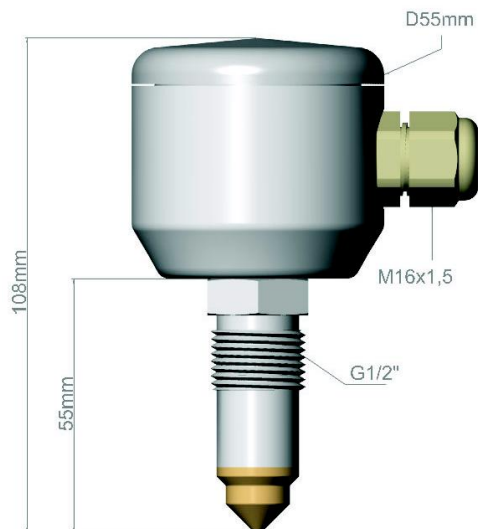

M12

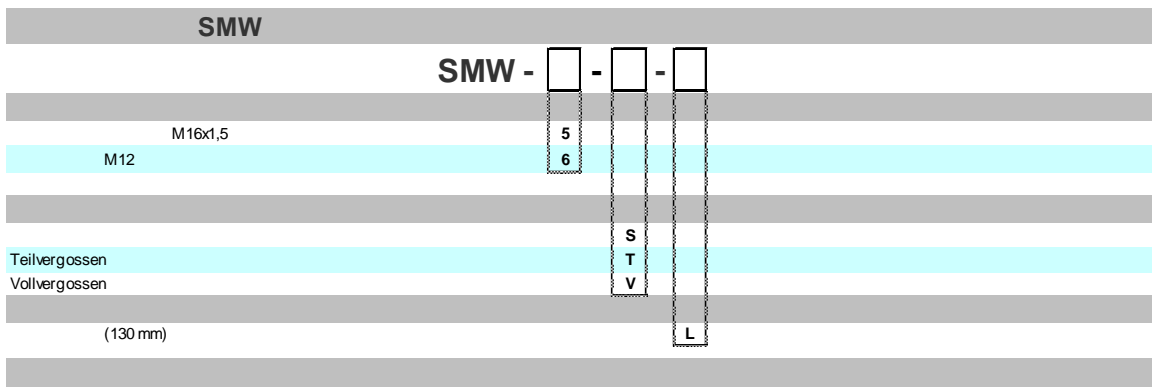
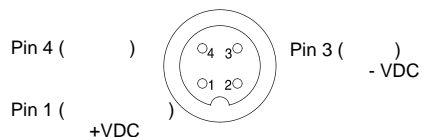

PC-USB

SMW

SMW - P A

modular @ process